

**ROBUSCH<sup>®</sup>**



# Multistage Centrifugal Blowers



**Evolving  
Technologies**



# Customized Solutions Unparalleled Expertise.

At Robuschi, we have been providing products and services in the low pressure market for a long time.

We have also supplied generations of customers worldwide with blower solutions.

Our unwavering commitment to developing long-term customer relationships, innovative product designs, and quality manufacturing is evident with millions of units manufactured. We are continually improving delivery and response times while setting the highest performance standards in the industry.

We are well aware that success is a process based on a stream of innovations and on working closely with our customers. Our latest innovation comes in the form of a blower boosted by turbo technology and now we are able to offer you an additional technology, multistage centrifugal, to our blower portfolio.

Currently, as a customer, you have access to a full spectrum of low pressure technologies, including lobe, screw, turbo and, now multistage centrifugal blowers.

You can now benefit from dealing with a single, well-established, knowledgeable supplier for every application.

At Robuschi, we are able to provide the most suitable solution for your needs that combines superior efficiency, a small footprint, minimum maintenance, operating costs, long service life and low noise emission.

Introducing a multistage centrifugal range of blowers, we are able to offer you the best combination of solution to fit your requirements, whatever your application and specifications.

*Regardless of your operating needs, we have the perfect solution for your (everyday) needs.*



# Multistage Centrifugal Blowers

## Serving a Wide Range of Applications

The range of applications for centrifugal products is ever-expanding, provides effective, affordable solutions for a variety of application needs.

### Water & Wastewater Treatment

In water & wastewater treatment, air is provided to water and wastewater aeration systems and air scouring/filter backwashing. Robuschi multistage blowers can be specified for coarse/fine bubble diffuser systems, reactor batch supplemental air, digester gas boosters, grit channels and sludge digestion applications.

- **Aeration**
- **Aerobic Digestion**
- **Biogas**
- **Digester Gas Boosters**
- **Filter Backwashing**
- **Air Scouring**
- **Grit Chambers**

### Industrial Processing

In the industrial market, our blowers provide air or gas for sulphur recovery, combustion air, process gas boosting, coal mine venting, fluidized bed combustion systems, vapour and gas extraction, composting, sludge incineration and printing systems, to name a few.

- **Aeration Basins**
- **Air Drying**
- **Air Flotation and Sliding**
- **Air Knife Stripping**
- **Blow-off Systems**
- **Carbon Black**
- **Coal Gasification**
- **Combustion Air Blowers**
- **FGD - Forced Oxidation**
- **Fluidized Bed**
- **Gas Boosting - O<sub>2</sub> / CO<sub>2</sub> / N<sub>2</sub>/etc.**
- **Gas Recovery**
- **Landfill Gas**
- **LNG Vaporizers**
- **Printing Operations - Turning Bars, Dryers, Binding Applications**
- **Pulp Dewatering**
- **Steel Plating Baths**
- **Sulphur Recovery**
- **Vapour Recompression**

### Engineered Vacuum Systems

Engineered Vacuum Systems are used to pick up, convey and capture a myriad of materials ranging from aluminium granules to corn flakes.

- **Clean Rooms**
- **Electronics**
- **Explosive Dust Collection**
- **Flux Recovery**
- **Housekeeping**
- **Nuisance Dust Collection**
- **Oral Evacuation**
- **OSHA Standard Required**
- **Pneumatic Conveying**
- **Powder Paint**
- **Product Reclamation**
- **Sanitary/Product Quality - Bakeries, Flour/Grain Mills, Food Products, Pharmaceuticals**
- **Source Capture**

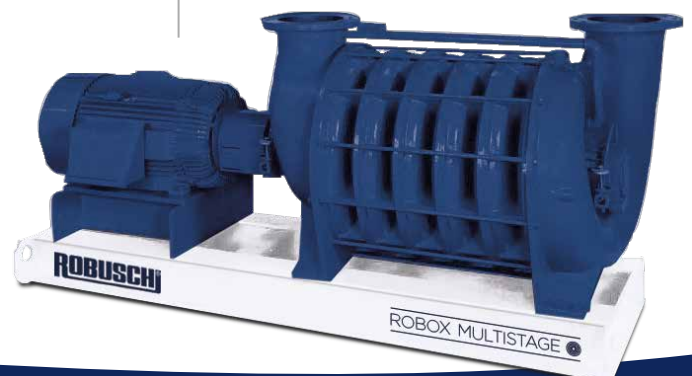

# Robox Multistage Outline

## SUPERIOR QUALITY In Design, Materials, and Manufacturing

Durable, reliable and efficient, Robuschi centrifugal blowers represent the highest quality in the industry using the finest materials and state-of-the-art machining tools available today. Our dedication to design and quality assures you the best in the industry.

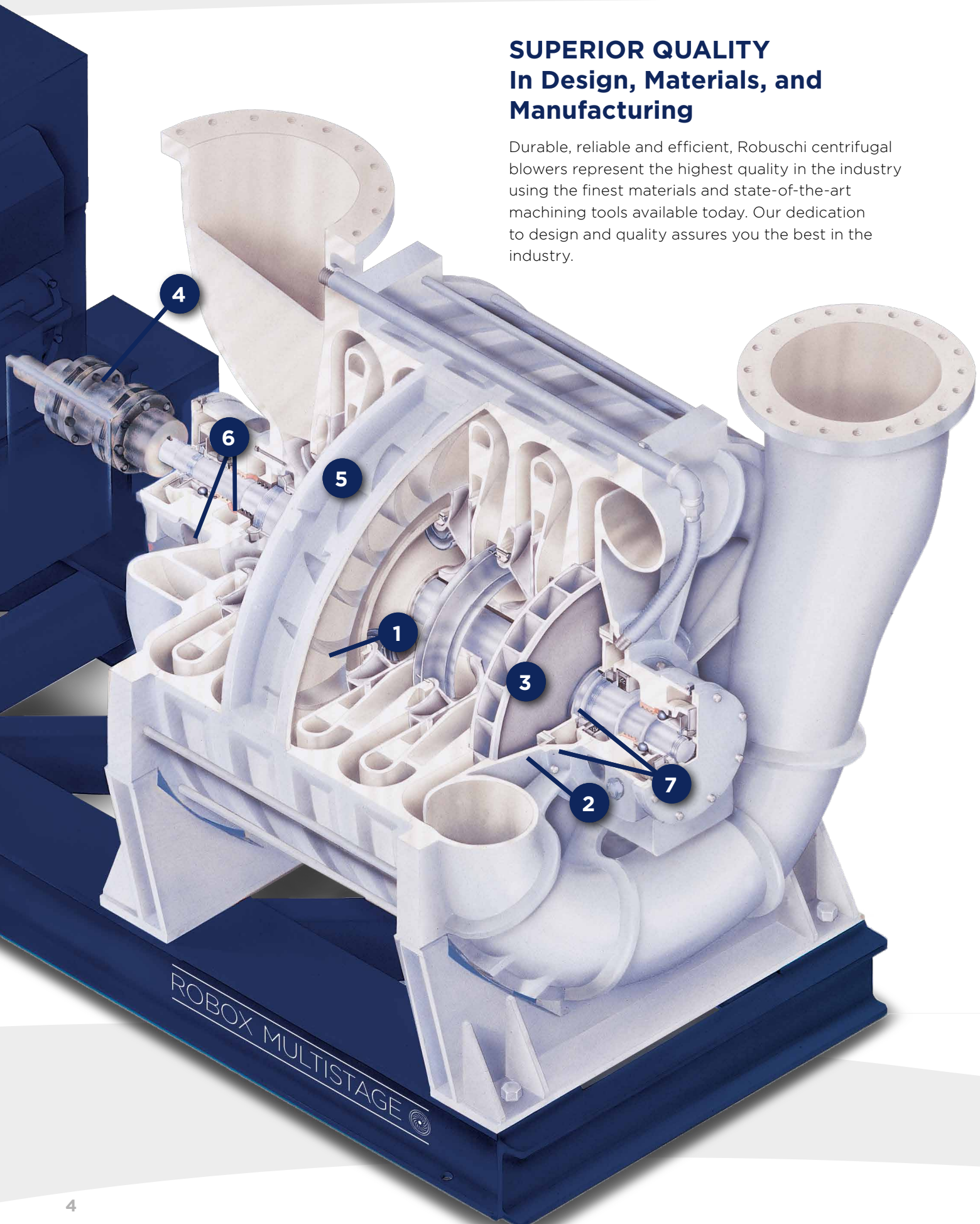

1



## Multiple Baffle Rings

Many models feature our patented Multiple Baffle Rings (MBR™) which help turn airflow smoothly into the eye of the impeller, dramatically reducing inlet passage losses. MBR combined with the two-dimensional impeller design increases blower efficiency and pressure/vacuum capability.

5



## Cast Housing

Blower housings are precision machined from high-grade cast iron. Smaller models are cast aluminium. The intermediate blower sections are assembled using high strength steel tie rods. The blower and its driver are mounted together on a single steel baseplate. This assures long lasting performance and durability.

2

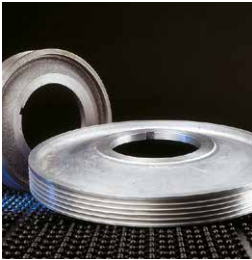

## Balance Piston

A balance piston is located at the outlet end of the rotating impeller assembly to compensate for the axial force of the impellers on the inlet bearing. This greatly increases bearing life for longer, trouble-free operation.

6



## Labyrinth Seal

Non-contact, non-wearing labyrinth air seals are standard. This no-maintenance seal is used in most air and some gas applications (purge option available). Carbon Ring seal for special air and gas applications requiring superior sealing, optional carbon ring seals are available with purge option.

3



## Multistage Shrouded Impellers

Two-dimensional shrouded cast aluminium impellers are balanced individually and keyed onto the shaft. On most blowers, the complete assembly is then balanced to achieve smooth operation with lowest vibration levels in the industry. Rotor assemblies are designed to operate well below first critical speeds for added reliability.

7

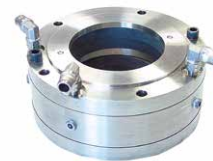

## Carbon Ring Seal

For special air and gas applications requiring superior sealing, optional carbon ring seals are available with purge option.

or

## MAX Seal

(Mechanical Axial)

An innovation in dry seal technology, the MAX Seal reduces fugitive emissions by up to 67% when compared to traditional seal options.

Ideal for landfill gas and applications handling toxic and explosive gases. Improves the safety of your operation while extending bearing life and lowering total cost of ownership.

4



## Flexible Coupling

Blowers connect directly to the power source with a precision aligned flexible coupling. This optimizes power transfer and minimizes bearing loads for longer life.



# Robox Multistage Range

The Robox Multistage range is able to reach up to 1,800 mbar(g) with a maximum flow of 70,000 m<sup>3</sup>/h.

## **50 Hz is our standard, but the 60 Hz is also available**

Robox Multistage models cover a broad performance range to meet our needs. Each base model presents its own unique performance characteristics and design features that are illustrated in the following pages.

Our Engineers are at your disposal to size the Robox Multistage to best fit your plant. They will provide all the technical information and support as well.



# Unique Features for Total Piece of Mind

## Superior Quality

In design, materials and workmanship. Multistage centrifugal blowers from Robuschi are durable, reliable and efficient. Manufactured from top quality materials with the most advanced production methods. Superior design and quality make the blowers from Robuschi the first choice for your applications.

## Innovative Design

Innovative product design and high quality production are the reasons we are able to meet the demanding requirements and applications in a wide range of processes. The Robuschi multistage centrifugal blowers offers a wide range of product for multiple applications.

## Extensive Range of Options

Various design options with over 22 standard models in the range. The Robuschi centrifugal Blowers can offer our customers a large number of options and additional designs such as special material coatings, alternative materials of construction, oil or grease lubrication, specialist seals and drive coupling options.

## High Performance

The Robuschi centrifugal blowers are tested at our modern testing facilities in Bentleyville, USA. To latest the latest ASME standards and in accordance with ISO and all other applicable international standards. The performance, noise level and vibration level are tested. The data is acquired in real time for evaluation and documentation.

## Multiple Drive Options

The centrifugal blowers from Robuschi can be manufactured with direct drive, v-belt or via a gearbox or transmission. Electric motors are the standard drive variant with alternative options including steam turbines and combustion motors.

## Advanced Monitoring & Control Systems

Our modern controls systems are designed to reliably operate your Robuschi blowers. They are designed to protect against conditions which can result in mechanical failure, and expensive down time. As a result they offer you the protection and the information you need for the maximum efficiency of your process. Our control systems monitor a wide range of parameters, such as motor current, motor temperature, blower vibration, bearing temperature, oil level and inlet/ outlet temperatures.

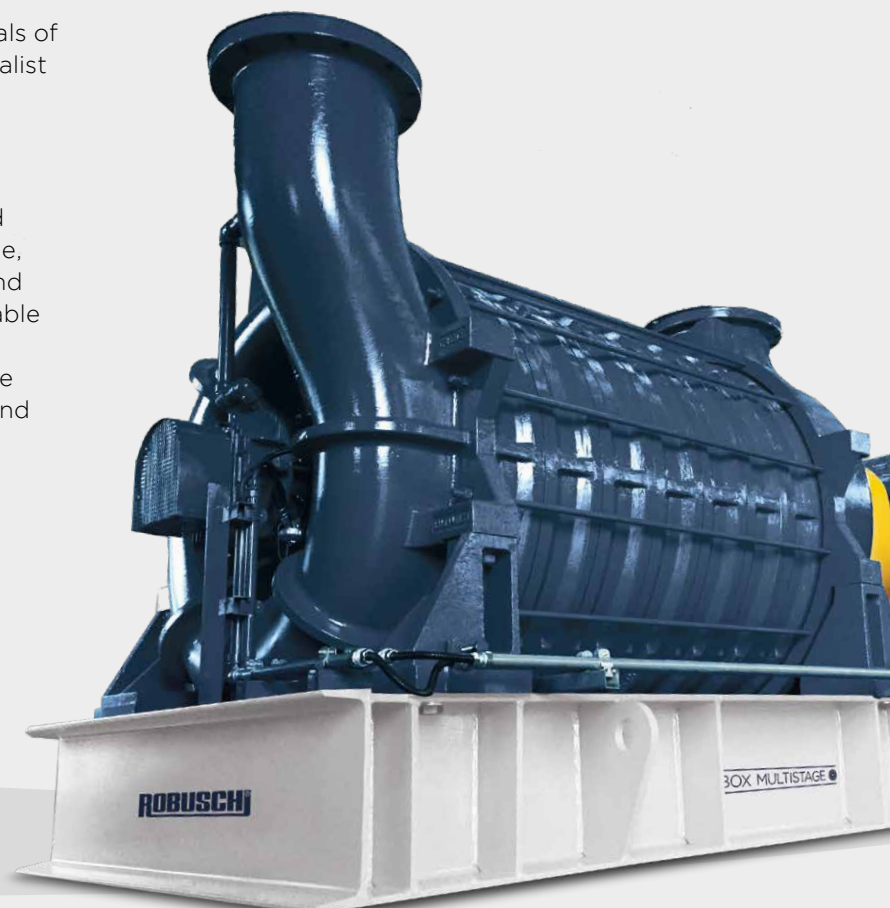

# Technical Data

Small Inlet Models:  
from 65 to 150 mm (DN 65 - DN 150)

## Performance Air Map

@ 1 bar, 20°C | 36%RH, speed: 3550 RPM

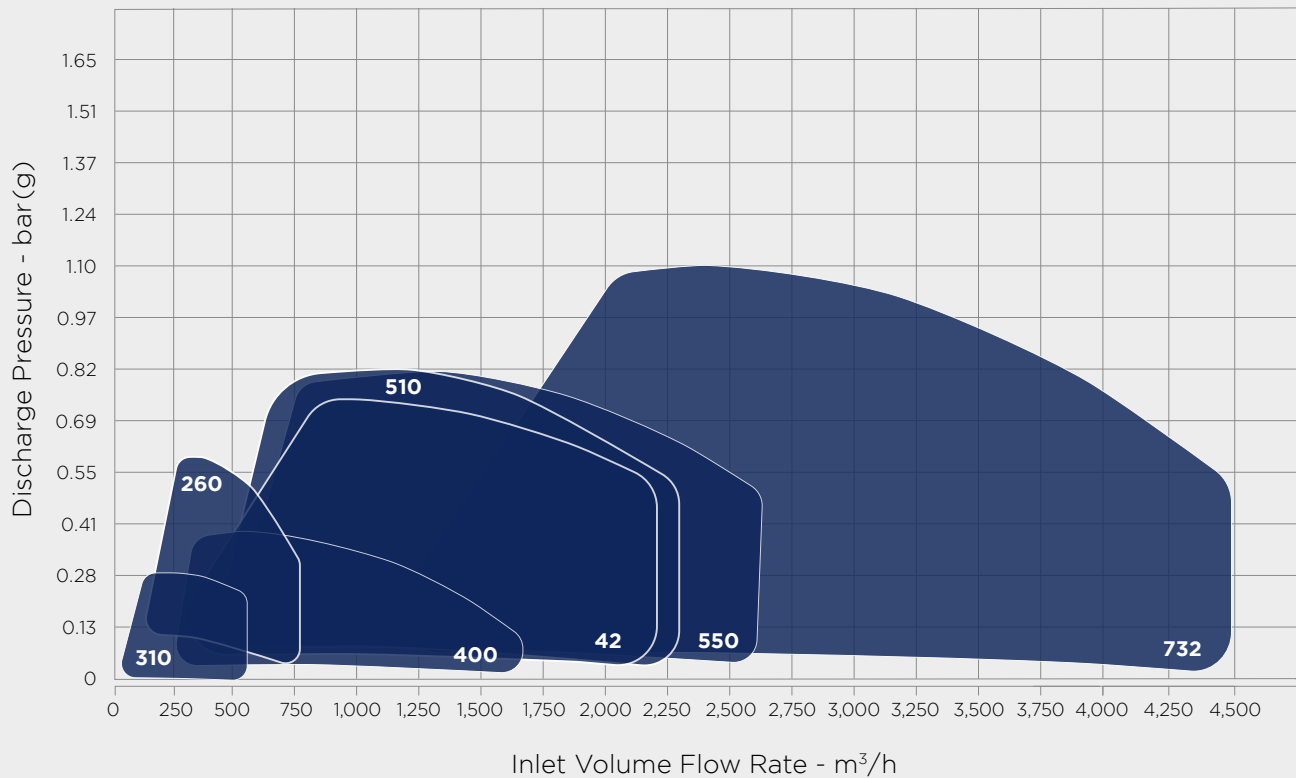

## Performance and Specifications

Blower Model	310	260	400	42	510	550	732
<b>Blower/Exhauster Capacity</b>							
Minimum Flow (m³/h)	405	170	120	85	255	340	650
Maximum Flow (m³/h)	765	680	1,785	2,050	2,210	2,210	4,100
Maximum Pressure (bar)	0.6	0.6	0.51	0.67	0.81	0.81	1.05
Maximum Vacuum (mmHg)	284	284	251	300	348	348	380
Maximum Number of Stages	11	5	10	8	10	10	10
<b>Design Benefits</b>							
Single Baffle Ring	-	-	-	-	-	■	■
Multiple Baffle Rings (MBR)	-	-	-	-	-	-	■
Balance Piston	-	-	-	-	-	-	8-10 STG
Lubrication	Grease	Grease	Grease	Grease/Oil	Grease/Oil	Grease/Oil	Grease/Oil
Auto-Lubrication System	■	■	■	■	■	■	■
Labyrinth Seal	■	■	■	-	■	■	■
Carbon Ring Seal	-	-	-	■	○	○	○
MAX (Mechanical Axial) Seal	-	-	-	-	■	■	■
<b>Connections</b>							
Inlet (DN/ANSI)	75 mm / 3"	62 mm / 2 1/2"	125 mm / 5"	150 mm / 6"	125 mm / 5"	150 mm / 6"	150 mm / 6"
Outlet (DN/ANSI)	75 mm / 3"	62 mm / 2 1/2"	125 mm / 5"	150 mm / 6"	125 mm / 5"	125 mm / 5"	150 mm / 6"

Information is approximate and subject to change without notice. Performances noted here are typical and not job specific. Consult with a Robuschi Representative for job specific blower or exhauster performance sizing.

■ Standard    ○ Optional    - Not available



# Technical Data

Medium Inlet Models:  
from 200 to 300 mm (DN 400 - DN 300)

## Performance Air Map

@ 1 bar, 20°C | 36%RH, speed: 3550 RPM

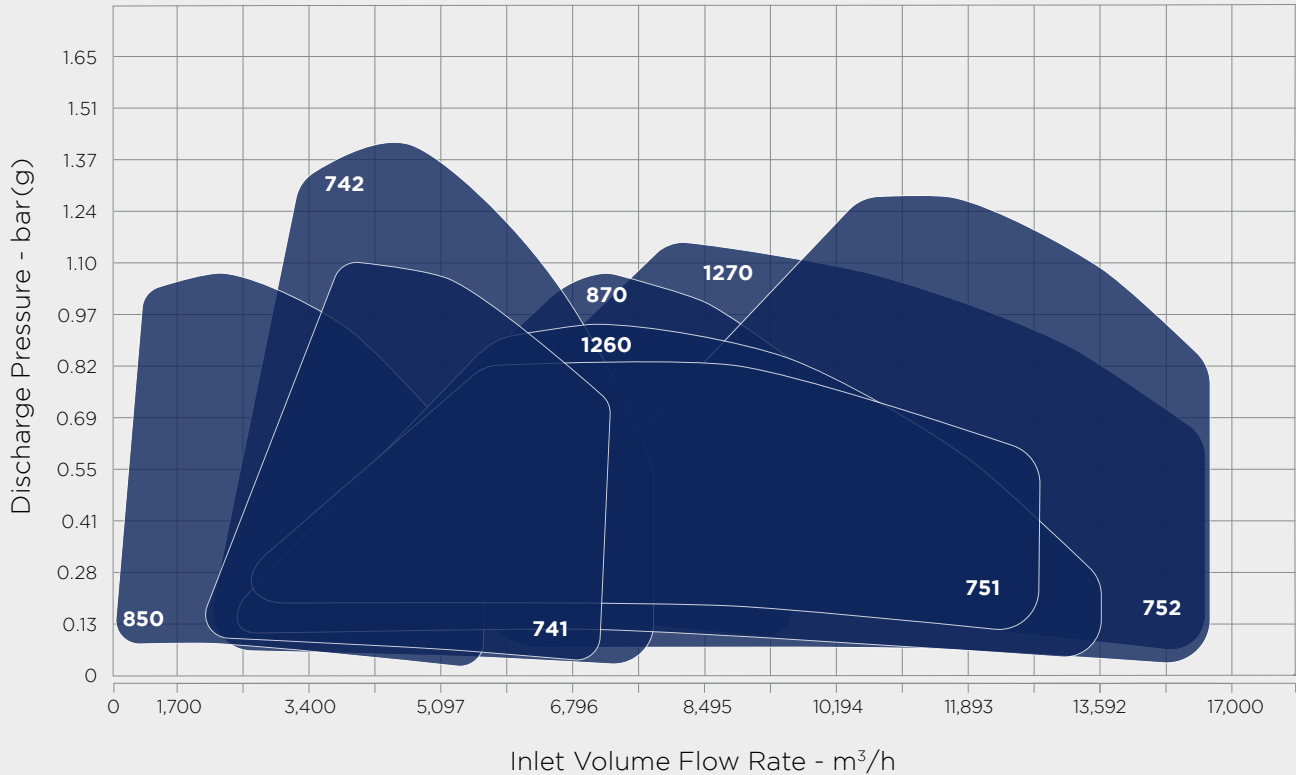

## Performance and Specifications

Blower Model	850	741	742	870	1260	1270	751	752
<b>Blower/Exhauster Capacity</b>								
Minimum Flow (m³/h)	935	1,100	1,200	1,700	2,125	2,000	1,600	5,500
Maximum Flow (m³/h)	5,440	7,500	8,100	9,350	13,600	14,400	14,500	15,300
Maximum Pressure (bar)	1.01	1.1	1.43	1.17	0.99	1.2	0.86	1.35
Maximum Vacuum (mmHg)	386	380	450	406	375	412	350	425
Maximum Number of Stages	9	9	11	10	8	9	7	10
<b>Design Benefits</b>								
Single Baffle Ring	■	■	■	■	■	-	■	■
Multiple Baffle Rings (MBR)	-	■	■	■	-	■	-	-
Balance Piston	-	8-10 STG	7-11 STG	5-10 STG	-	4-9 STG	-	4-10 STG
Lubrication	Grease/Oil	Grease/Oil	Grease/Oil	Grease/Oil	Grease/Oil	Grease/Oil	Oil	Oil
Auto-Lubrication System	■	■	■	■	■	■	-	-
Labyrinth Seal	■	■	■	■	■	■	■	■
Carbon Ring Seal	○	○	○	○	○	○	○	○
MAX (Mechanical Axial) Seal	■	■	■	■	■	■	■	-
<b>Connections</b>								
Inlet (DN/ANSI)	200 mm / 8"	200 mm / 8"	250 mm / 10"	250 mm / 10"	300 mm / 12"	350 mm / 14"	300 mm / 12"	350 mm / 14"
Outlet (DN/ANSI)	200 mm / 8"	200 mm / 8"	200 mm / 8"	200 mm / 8"	300 mm / 12"	300 mm / 12"	300 mm / 12"	250 mm / 10"

Information is approximate and subject to change without notice. Performances noted here are typical and not job specific. Consult with a Robuschi Representative for job specific blower or exhauster performance sizing.

■ Standard    ○ Optional    - Not available

# Technical Data

Large Inlet Models:  
from 350 to 750 mm (DN 350 - DN 800)

## Performance Air Map

@ 1 bar, 20°C | 36%RH, speed: 3550 RPM

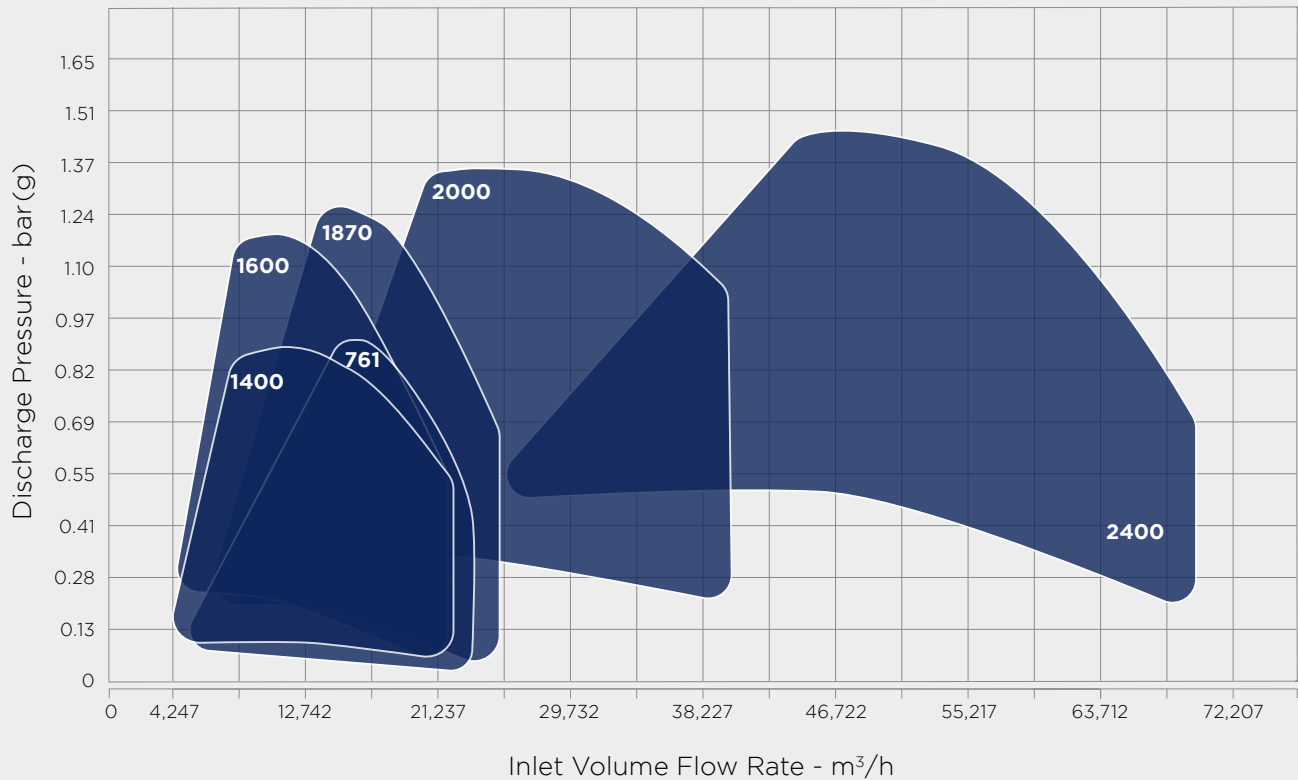

## Performance and Specifications

Blower Model	1400	1600	761	1870	2000	2400
<b>Blower/Exhauster Capacity</b>						
Minimum Flow (m³/h)	3,900	5,100	2,100	5,100	8,500	17,000
Maximum Flow (m³/h)	24,650	20,400	24,600	25,500	50,800	68,000
Maximum Pressure (bar)	0.87	1.17	0.9	1.31	1.7	1.52
Maximum Vacuum (mmHg)	351	406	350	432	477	447
Maximum Number of Stages	8	8	7	7	8	6
<b>Design Benefits</b>						
Single Baffle Ring	■	-	■	-	-	-
Multiple Baffle Rings (MBR)	-	■	-	-	■	■
Balance Piston	-	4-8 STG	5-8 STG	3-7 STG	3-8 STG	3-6 STG
Lubrication	Oil	Oil	Oil	Oil	Oil	Oil
Auto-Lubrication System	-	-	-	-	-	-
Labyrinth Seal	■	■	■	■	■	■
Carbon Ring Seal	○	○	○	○	○	○
MAX (Mechanical Axial) Seal	■	-	■	-	-	-
<b>Connections</b>						
Inlet (DN/ANSI)	450 mm / 18"	400 mm / 16"	350 mm / 14"	500 mm / 20"	500 mm / 20"	600 mm / 24"
Outlet (DN/ANSI)	350 mm / 14"	350 mm / 14"	350 mm / 14"	450 mm / 18"	450 mm / 18"	500 mm / 20"

Information is approximate and subject to change without notice. Performances noted here are typical and not job specific. Consult with a Robuschi Representative for job specific blower or exhauster performance sizing.

■ Standard    ○ Optional    - Not available

# Technical Data

**900 Series:**  
Inlet from 150 to 500 mm (DN 150 - DN 500)

## Performance Air Map

@ 1 bar, 20°C | 36%RH, speed: 3000 RPM

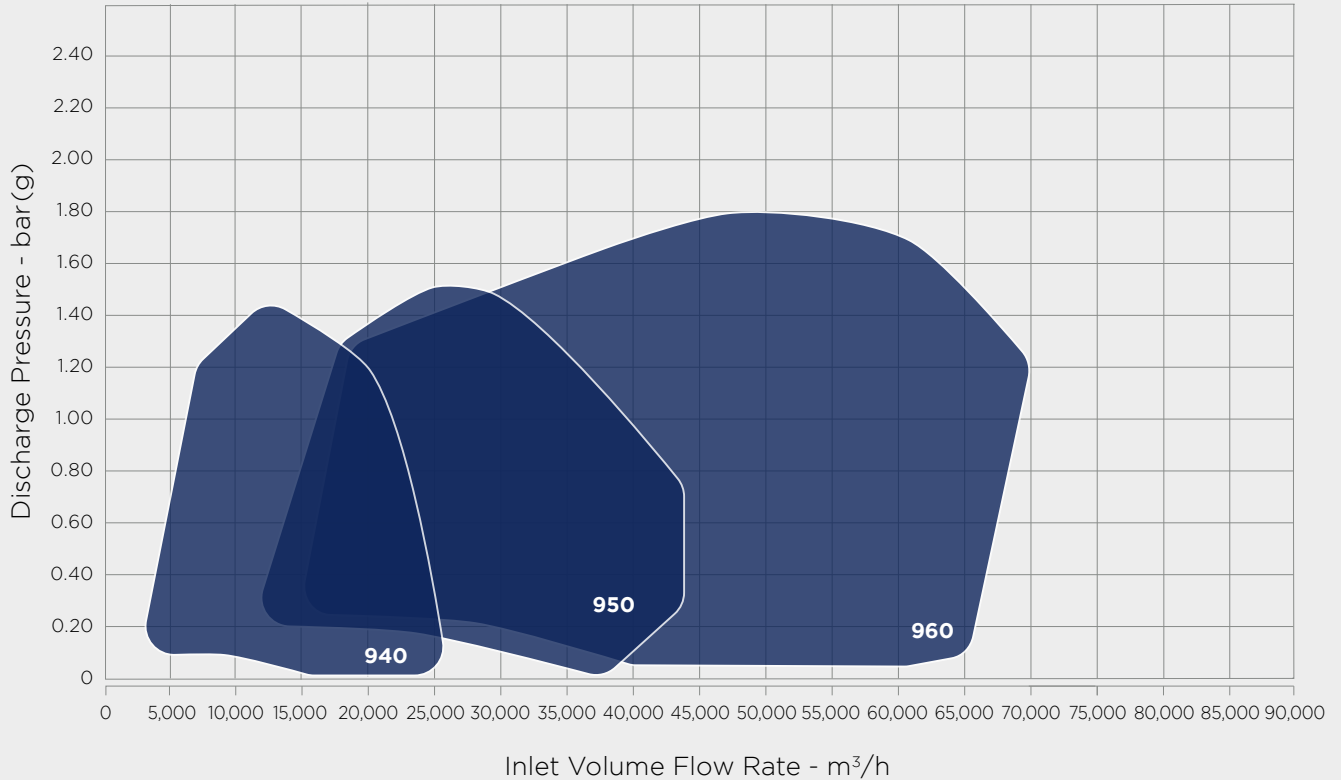

## Performance and Specifications

Blower Model	940	950	960
<b>Blower/Exhauster Capacity</b>			
Minimum Flow (m³/h)	5,232	6,598	12,545
Maximum Flow (m³/h)	26,193	45,365	70,238
Maximum Pressure (bar)	1.8	1.6	1.7
Maximum Vacuum (mmHg)	400	380	425
Maximum Number of Stages	9	8	6
<b>Design Benefits</b>			
Single Baffle Ring	-	-	-
Multiple Baffle Rings (MBR)	-	-	-
Balance Piston	■	■	■
Lubrication	Oil	Oil	Oil
Auto-Lubrication System	-	-	-
Labyrinth Seal	■	■	■
Carbon Ring Seal	■	■	■
MAX (Mechanical Axial) Seal	-	-	-
<b>Connections</b>			
Inlet (DN/ANSI)	400 mm / 16"	500 mm / 20"	600 mm / 24"
Outlet (DN/ANSI)	350 mm / 14"	450 mm / 18"	500 mm / 20"

Information is approximate and subject to change without notice. Performances noted here are typical and not job specific. Consult with a Robuschi Representative for job specific blower or exhauster performance sizing.

■ Standard      - Not available



# Engineered-To-Order

## Complete Blower Solutions that are Engineered-To-Order

Robuschi specializes in the design and manufacture of engineered systems that are tailored to your application and specifications.

Our ETO systems include energy saving controls and VFD's, a wide range of accessories, and durable materials constructed around reliable Robuschi products.

All Robuschi systems are backed by a complete system warranty and global aftermarket support and service, to ensure your operations run smoother, longer and more reliably.

From engineering to manufacture, and aftermarket services; Robuschi is your single source solution for custom engineered systems.

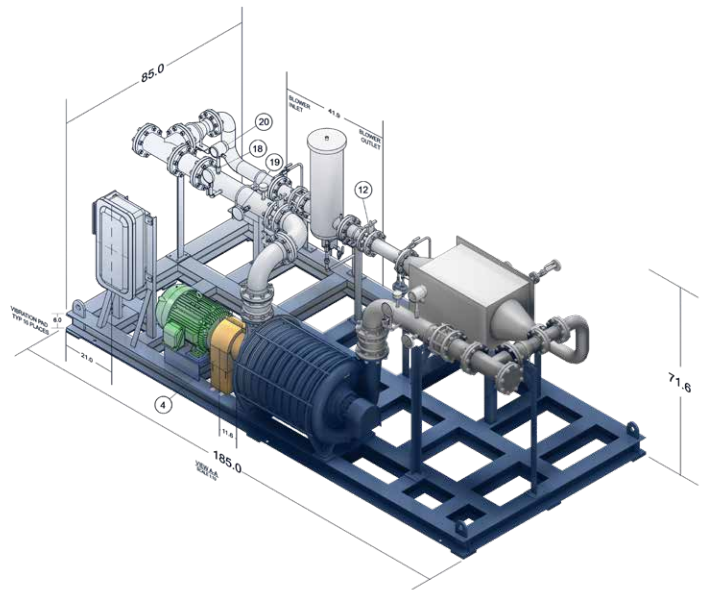

# ROBUSCH®

## Robox Range to Boost Your Bottom Line



### Full Spectrum of Blowers

Positive displacement:

Robox Lobe and Robox Screw

Centrifugal:

Robox Turbo and Robox Multistage

Range up to 2,500 mbar and  
flow up to 70,000 m<sup>3</sup>/h.

ROBOX   
LOBE

ROBOX   
SCREW

ROBOX   
TURBO

ROBOX   
MULTISTAGE



## Maximum uptime. Extending performance.

We provide a range of services to ensure our customers' machines are well maintained to deliver maximum performance.

We offer preventative and planned maintenance programs, genuine parts, on-site service, professional maintenance and efficient training.

Within our service portfolio, you will find many and varied options and services needed to get optimal performance, maximum uptime and operating efficiency from your Robuschi equipment.



Find your Genuine Parts at



**GENUINE  
PARTS**

Scan the QR code

### **GARDNER DENVER S.r.l. Divisione ROBUSCHI**

#### **Manufacturing facilities**

Via S. Leonardo, 71/A  
43122 Parma - Italy  
Phone: +39 0521 274 911

Filiale di Milano  
Phone: +39 02 51 62 80 65

Filiale di Padova  
Phone: +39 049 807 8260

[info.italy@gardnerdenver.com](mailto:info.italy@gardnerdenver.com)

### **GARDNER DENVER NEDERLAND B.V.**

Barwoutswaarder 3  
3449 Woerden  
Netherlands  
Phone: +31 348 410 150  
[robuschi-benelux@gardnerdenver.com](mailto:robuschi-benelux@gardnerdenver.com)

### **GARDNER DENVER Ltd. United Kingdom**

Claybrook Drive,  
Washford Industrial Estate  
Redditch, B98 0DS - UK  
Phone: +44 1527 838 200  
[sales.red@gardnerdenver.com](mailto:sales.red@gardnerdenver.com)



[www.robuschi.com](http://www.robuschi.com)